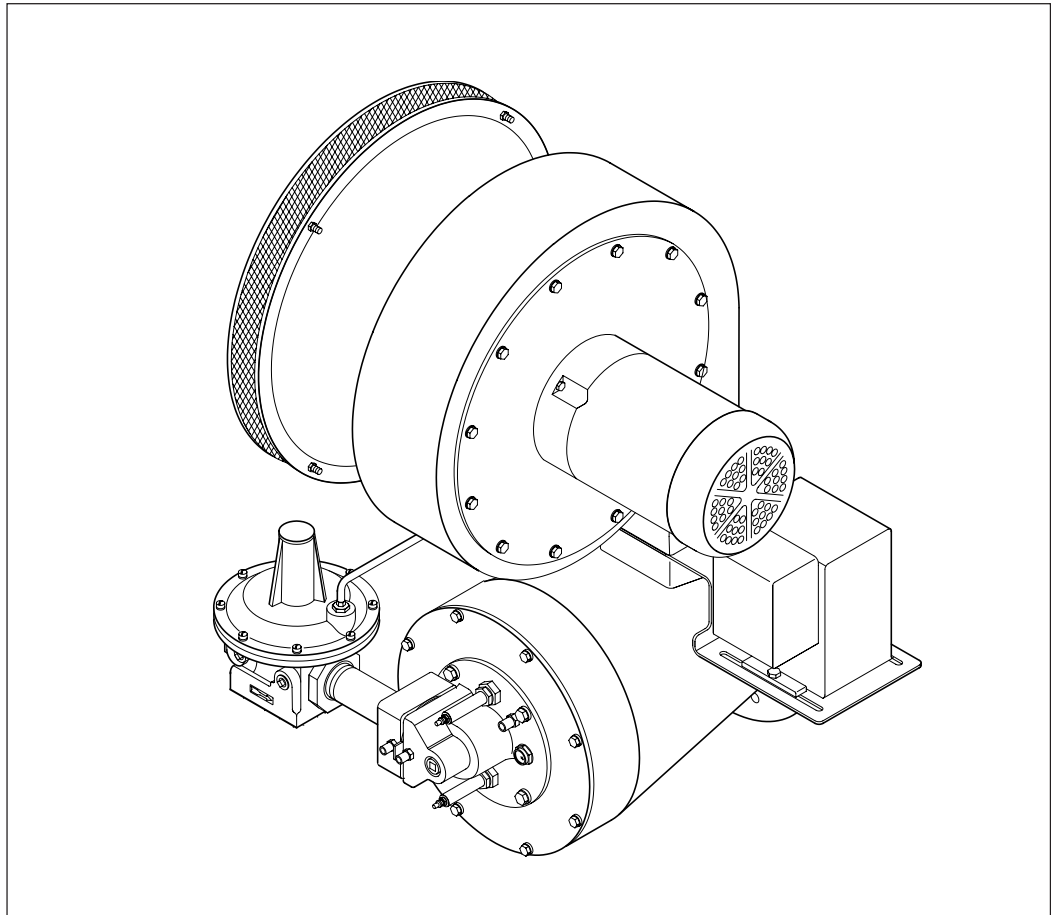




# ***Immersion Burners***

*ImmersoJet Series*

*version 2.20*



## **COPYRIGHT**

Copyright 1997 by Eclipse Combustion, Inc. All rights reserved worldwide. This publication is protected by federal regulation and shall not be copied, distributed, transmitted, transcribed or translated into any human or computer language, in any form or by any means, to any third parties, without the express written consent of Eclipse Combustion, Inc., Rockford, Illinois, U.S.A.

## **DISCLAIMER NOTICE**

We reserve the right to change the construction and/or configuration of our products at any time without being obliged to adjust earlier supplies accordingly.

The material in this manual is believed adequate for the intended use of the product. If the product, or its individual modules or procedures, are used for purposes other than those specified herein, confirmation of their validity and suitability must be obtained. Eclipse Combustion, Inc. warrants that the material itself does not infringe any United States patents. No further warranty is expressed or implied.

We have made every effort to make this manual as accurate and complete as possible. Should you find errors or omissions, please bring them to our attention so that we may correct them. In this way we hope to improve our product documentation for the benefit of our customers. Please send your corrections and comments to our Documentation Manager.

## **LIABILITY AND WARRANTY**

It must be understood that Eclipse Combustion's liability for its products, whether due to breach of warranty, negligence, strict liability, or otherwise, is limited to the furnishing of such replacement parts and Eclipse Combustion will not be liable for any other injury, loss, damage or expenses, whether direct or consequential, including but not limited to loss of use, income of or damage to material arising in connection with the sale, installation, use of, inability to use or the repair or replacement of Eclipse Combustion's products.

Any operation expressly prohibited in this Guide, any adjustment, or assembly procedures not recommended or authorized in these instructions shall void the warranty.



# About this manual

## AUDIENCE

This manual has been written for people who are already familiar with all aspects of an immersion burner and its add-on components, also referred to as “the burner system.”

These aspects are:

- design/selection
- use
- maintenance.

The audience is expected to have experience with this kind of equipment.

## IMMERSO JET DOCUMENTS

Design Guide No. 330

- This document

Data Sheet No. 330-2, 330-3, 330-4, 330-6, 330-7, 330-8

- Available for individual IJ models
- Required to complete design calculations in this guide

Installation Guide No. 330

- Used with Data Sheet to complete installation

Price List No. 330

- Used to order burners

## RELATED DOCUMENTS

- EFE 825 (Combustion Engineering Guide)
- Eclipse bulletins and Info Guides:  
610, 710, 720, 730, 744, 760, 930

Purpose

The purpose of this manual is to make sure that the design of a safe, effective and trouble-free combustion system is carried out.

## DOCUMENT CONVENTIONS

There are several special symbols in this document. You must know their meaning and importance.

The explanation of these symbols follows below. Please read it thoroughly.



### **Danger:**

---

**Indicates hazards or unsafe practices which **WILL** result in severe personal injury or even death.**

**Only qualified and well trained personnel are allowed to carry out these instructions or procedures.**

**Act with great care and follow the instructions.**

---



### **Warning:**

**Indicates hazards or unsafe practices which could result in severe personal injury or damage.**

**Act with great care and follow the instructions.**



### **Caution:**

*Indicates hazards or unsafe practices which could result in damage to the machine or minor personal injury.*

*Act carefully.*



### **Note:**

*Indicates an important part of the text. Read thoroughly.*

## HOW TO GET HELP

If you need help, you can contact your local Eclipse Combustion representative. You can also contact Eclipse Combustion at any of the addresses listed on the back of this document.



# *Table of Contents*

**1**

**About this manual ..... 3**

**Table of contents ..... 5**

**Introduction ..... 7**

Product Description ..... 7

**2**

**Safety ..... 9**

Introduction ..... 9

Safety ..... 9

Capabilities ..... 10

Operator Training ..... 10

Replacement Parts ..... 10

**3**

**System Design ..... 11**

Step 1: Burner model selection ..... 11

Step 2: Tube design ..... 13

Step 3: Control methodology ..... 15

Step 4: Ignition system ..... 16

Step 5: Flame monitoring system ..... 16

Step 6: Combustion air system ..... 17

Step 7: Main gas shut-off valve train ..... 20

Step 8: Process temperature control system ..... 20

**Appendix ..... 21**

Key to the system schematics ..... 22

This page left blank intentionally.

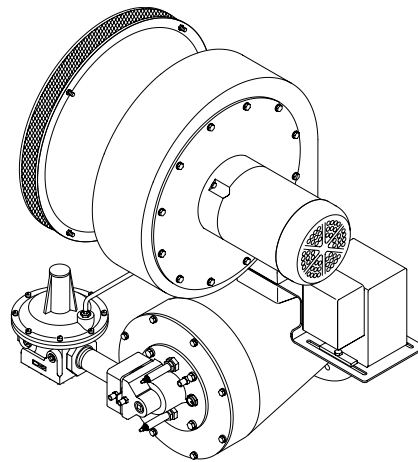
# Introduction

# 1

## PRODUCT DESCRIPTION

The Immersojet (IJ) is a nozzle-mix tube-firing burner that is designed to fire at high velocities through small diameter immersion tubes. The standard burner includes a packaged blower, actuator control motor, integral butterfly valve, ratio regulator, burner body, combustion chamber, nozzle (specific to fuel used), rear cover, spark and flame rods, and gas orifice (also specific to fuel used).

**Figure 1.1 The Immersojet Burner**



## FEATURES

The combustion gases from the burner scrub the inner tube surface and produce high heat transfer rates. This, in combination with the high velocity flow through the smaller diameter tubes allows for system efficiencies in excess of 80%.

The smaller Immersojet tubes also have smaller bends which means less tank space is occupied by the tubes. With a combustion chamber that is integral to the burner body, the new version of the Immersojet can sit lower on the tank than previous Immersojet models.



# 2

## INTRODUCTION

## SAFETY

In this section you will find important notices about safe operation of a burner system.



### **Danger:**

---

**The burners covered in this manual are designed to mix fuel with air and burn the resulting mixture. All fuel burning devices are capable of producing fires and explosions when improperly applied, installed, adjusted, controlled or maintained.**

**Do not bypass any safety feature; You can cause fires and explosions.**

**Never try to light the burner if the burner shows signs of damage or malfunctioning.**

---



### **Warning:**

**The burner is likely to have HOT surfaces. Always wear protective clothing when approaching the burner.**



### **Note:**

This manual gives information for the use of these burners for their specific design purpose. Do not deviate from any instructions or application limits in this manual without written advice from Eclipse Combustion.

Read this entire manual before you attempt to start the system. If you do not understand any part of the information in this manual, then contact your local Eclipse representative or Eclipse Combustion before you continue.



## C APABILITIES

Adjustment, maintenance and troubleshooting of the mechanical and the electrical parts of this system should be done by qualified personnel with good mechanical aptitude and experience with combustion equipment.

## O PERATOR T RAINING

The best safety precaution is an alert and competent operator. Thoroughly instruct operators so they demonstrate an understanding of the equipment and its operation. Regular retraining must be scheduled to maintain a high degree of proficiency.

## R EPLACEMENT    P ARTS

Order replacement parts from Eclipse only. Any customer-supplied valves or switches should carry UL, FM, CSA, CGA and/or CE approval where applicable.

# System Design

# 3

## DESIGN

### STEP 1: BURNER MODEL SELECTION

Designing a burner system is a straightforward exercise. The steps are:

1. Burner model selection.
  - a. Determine net input required for the tank or process
  - b. Select tube efficiency
  - c. Calculate gross input required
  - d. Select burner model
2. Tube design.
3. Control methodology.
4. Ignition system.
5. Flame monitoring system.
6. Combustion air system: blower and air pressure switch.
7. Main gas shut-off valve train.
8. Process temperature control system.

#### Determine the net input required to the tank

The net input to the tank is determined from heat balance calculations. These calculations are based on the heatup and steady-state requirements of the process, and take into account surface losses, tank wall losses and tank heat storage. Detailed guidelines for heat balance calculations are in the Eclipse Combustion Engineering Guide (EFE 825).

#### Select tube efficiency

The efficiency of the tube is the net heat input to the tank divided by the heat input to the tube. Efficiency is determined by the effective tube length. The diameter of the tube has little influence on the efficiency. At a given burner input, the net input to the tank is higher for a longer tube than for a relatively short tube.

It is customary to size conventional immersion tubes for 70% efficiency, a reasonable compromise between fuel economy and tube length. However, small diameter tubes occupy less tank space than conventional tubes, so their length can easily be increased to provide efficiencies of 80% or more.

#### Calculate the gross burner input

Use this formula to calculate gross burner input in Bth/hr:

$$\frac{\text{net output to tank}}{\text{tube efficiency}} = \text{gross burner input}$$

## Fuel Type

Table 3.1 Fuel Type

Fuel	Symbol	Gross Heating Value	Specific Gravity	WOBBE Index
Natural Gas	CH <sub>4</sub> 90%+	1000 BTU/ft <sup>3</sup> (40.1 MJ/m <sup>3</sup> )	0.60	1290 BTU/ft <sup>3</sup>
Propane	C <sub>3</sub> H <sub>8</sub>	2525 BTU/ft <sup>3</sup> (101.2 MJ/m <sup>3</sup> )	1.55	2028 BTU/ft <sup>3</sup>
Butane	C <sub>4</sub> H <sub>10</sub>	3330 BTU/ft <sup>3</sup> (133.7 MJ/m <sup>3</sup> )	2.09	2303 BTU/ft <sup>3</sup>
BTU/ft <sup>3</sup> @ standard conditions (MJ/m <sup>3</sup> @ normal conditions)				

If using an alternative fuel supply, contact Eclipse with an accurate breakdown of the fuel components.

## BURNER MODEL SELECTION (CONTINUED)

### Applications requiring special consideration:

Immersojet burners are used for firing spray wash tanks, dip tanks, and storage tanks such as those used for fire sprinkler systems. Generally, the small bore system can be used wherever conventional immersion burner systems are used, except where high heat flux off the small bore tube can break down the tanks contents.

### Zinc phosphate solutions

High heat fluxes break down the phosphate, forming a heavy insulating sludge which deposits on tube surfaces and causes rapid tube burnout. To reduce early tube failure, make the immersion tube with electro-polished stainless steel, and limit the burner to capacity shown in the limited capacity portion of Figure 3.1 based on tube size.

### Iron phosphate solutions

These are susceptible to the same problem described above for zinc phosphate solutions. To reduce early tube failure, make the immersion tube with stainless steel. Electro-polishing is not required. Limit the burner to capacity shown in the limited capacity portion of Figure 3.1 based on tube size.

### Cooking oils

To avoid burning the oil, limit heat flux to 50 Btu/hr per square inch of tube area.

### Highly viscous liquids

All immersion systems depend on natural convection currents to carry heat away from the tube and throughout the tank. Convection is minimal in high viscosity solutions, such as asphalt, residual oil or molasses. This can severely overheat the liquid around the tube..



### Caution

*Do not use the Immersojet for highly viscous fluids*

### Select burner model

Choose a burner model with a maximum capacity greater than the gross burner input calculated previously. Refer to Figure 3.1.

**Figure 3.1 Capacity Guide**

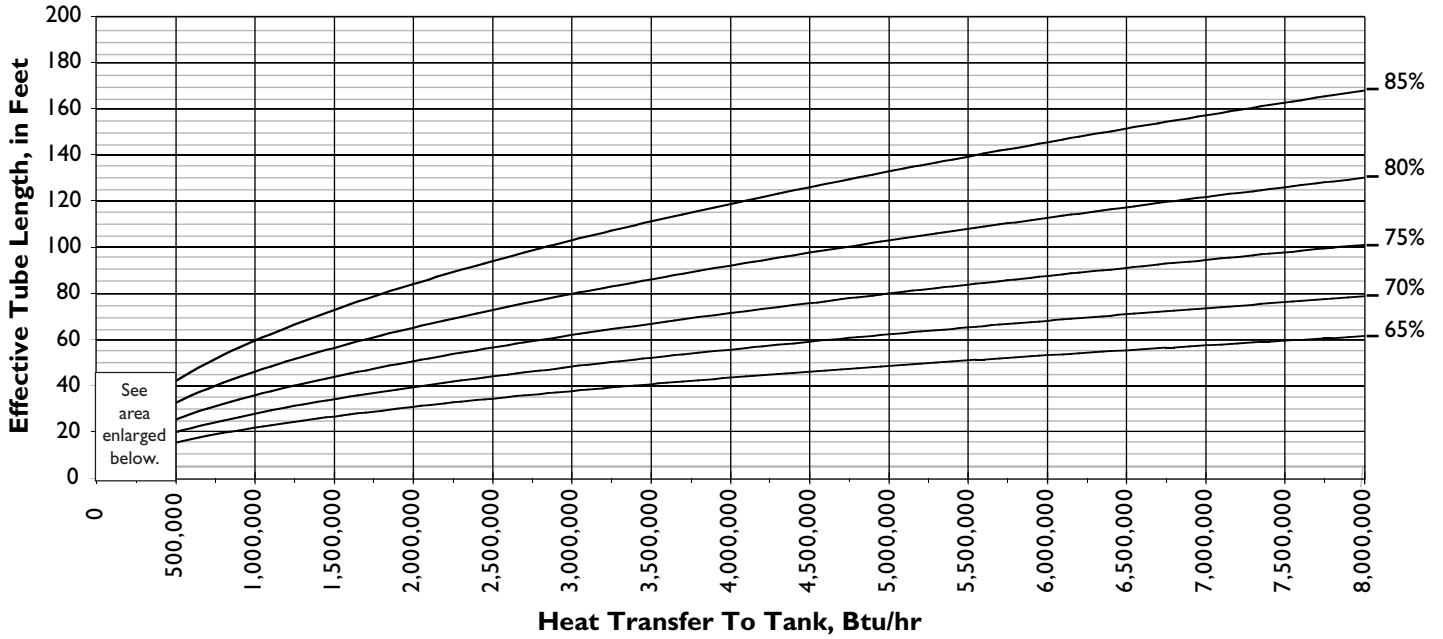
Model	Tube Size		Low-Pressure Packaged Blower		High-Pressure Packaged Blower		Remote Blower		Limited Capacity			
	in.	mm	Btu/hr.	kW	Btu/hr.	kW	Btu/hr.	kW	Zinc Phosphate Btu/hr.	kW	Iron Phosphate Btu/hr.	kW
2" IJv2	2	50	190,000	55	235,000	69	370,000	108	110,000	32	220,000	64
3" IJv2	3	80	440,000	129	550,000	161	850,000	249	250,000	73	500,000	146
4" IJv2	4	100	830,000	243	1,000,000	293	1,800,000	527	440,000	129	880,000	258
6" IJv2	6	150	2,000,000	586	2,500,000	732	3,600,000	1054	1,000,000	293	2,000,000	586
8" IJv1	8	200	n/a	n/a	n/a	n/a	8,000,000	2344	1,800,000	527	3,600,000	1055

## STEP 2: TUBE DESIGN

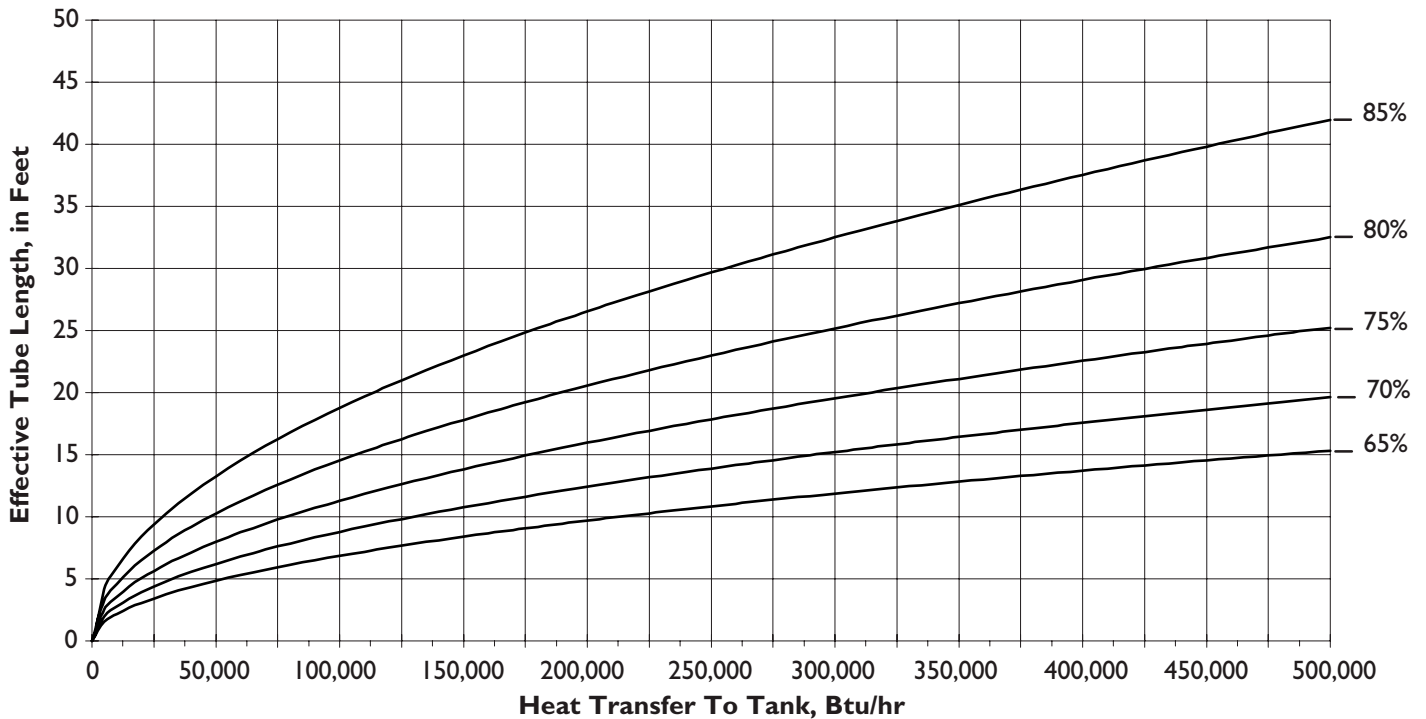
### Determine effective tube length

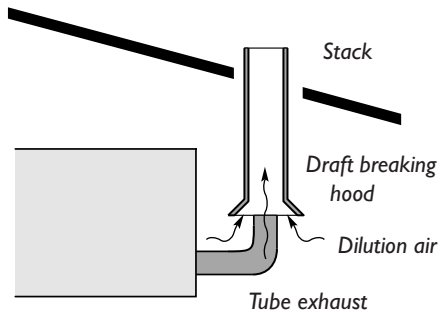
Find the required effective tube length using the previously selected tube efficiency, net heat input values and the following figures 3.2. or 3.3. The effective length of a tube is the total centerline length of tube covered by liquid.

**Figure 3.2 Effective Tube Length to 200 ft.**

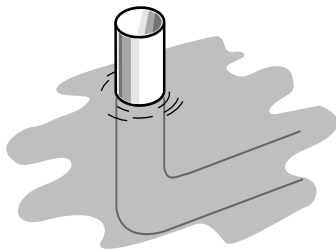


**Figure 3.3 Effective Tube Length to 50 ft.**

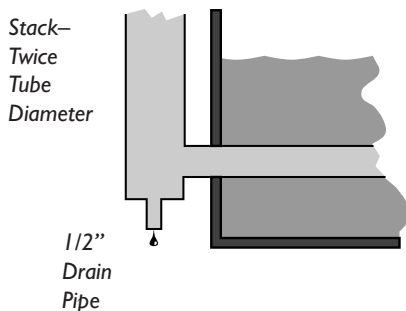




#### Efficiencies less than 80%



#### Efficiencies 80% or more



### Elbows

- Use standard and sweep elbows only.
- For maximum tube life place the first elbow eight tube diameters from the burner.

### Stack

- Make sure that the stack is large enough to handle the heated exhaust flow plus the dilution air.
- The stack must be at least one pipe size larger than the tube exhaust.



#### Note:

If you use a common stack for more than one burner, then make sure that the stack is large enough to handle the exhaust flow plus any dilution air from all the burners. Detailed guidelines for flue sizing calculations are in the Eclipse Combustion Engineering Guide (EFE 825).

### Draft breaking hood

A draft breaking hood is an open connection between the heater tube exhaust and the exhaust stack. It allows fresh dilution air to pass into the exhaust and mix with the exhaust gases.

The advantages of a draft hood are:

- the burner operation is less sensitive to atmospheric conditions
- the temperature of the exhaust gases is lower when they pass through the roof.



#### Note:

Leave access between the draft hood and the tube exhaust. Install a damper plate if acoustic feedback occurs in the tube.

### Condensate provisions

If the immersion tube will operate at efficiencies less than 80%, the exhaust leg can be raised through the liquid surface. For efficiencies of 80% or higher, locate the exhaust stack outside of the tank and provide a drain.



#### Note:

Regardless of the exhaust design, pitch the immersion tube down towards the exhaust so condensate will not collect at the burner.



#### Caution:

At efficiencies of 80% or greater, low exhaust temperatures will cause condensation to form in the tube at start-up or during long idling periods. The higher the efficiency the more condensation will increase.

To prevent condensation/corrosion from shortening tube life or disrupting burner operation, provide a condensate drain at the exhaust and slope the immersion tube downward, away from the burner.

### Tube placement in tank

The tube placement height in the tank should be high enough to avoid the possibility of sludge build-up on the bottom of the tank; however, it should be low enough to avoid tube exposure due to liquid level variations caused by evaporation or displacement. In the latter case use a liquid level switch to shut down the burner.

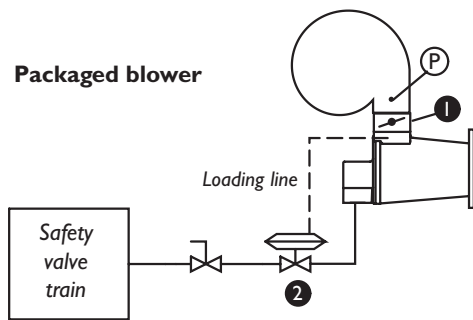
## STEP 3: CONTROL SYSTEM

### Control methodology

ImmersoJet burners use a modulating on-ratio control system as shown in Figure 3.3. To control the heat delivered by the burner, adjust the air flow to the burner. The gas flow will change in proportion to the air flow.

The burner will operate reliably at any input between the low fire and high fire limits stated on the burner's Data Sheet.

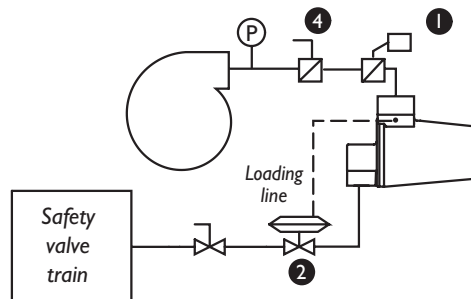
Figure 3.3 System Schematics



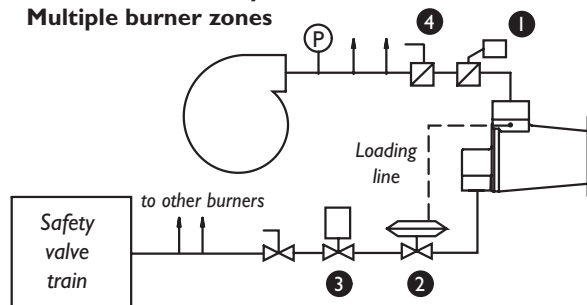
### Components

- ① Automatic butterfly valve
- ② Ratio regulator: varies gas flow to burner in proportion to air flow.
- ③ Automatic shut-off valve (optional).
- ④ Manual butterfly valve

### Remote blower with External air butterfly valve



### Remote blower with External air butterfly valve—Multiple burner zones



## STEP 4: IGNITION SYSTEM

### For the ignition system you should use:

- 6000 VAC transformers
- full wave spark transformers
- one transformer per burner.

### Do not use:

- 10,000 VAC transformers
- twin outlet transformers
- distributor type transformers
- half wave spark transformers.

ImmersoJet burners will ignite reliably at any input within the ignition zone shown in the appropriate burner data sheet. However, it is recommended that low fire start be used. Local safety and insurance requirements demand that you limit the maximum time that a burner takes to ignite. These time limits vary from country to country.

### The time that a burner takes to ignite depends on:

- the distance between the gas shut-off valve and the burner
- the air/gas ratio
- the gas flow at start conditions.

In the USA, with a time of 15 seconds to ignition, there should be sufficient time to ignite the burners. It is possible, however, to have the low fire too low to ignite within the time limit. Under these circumstances you must consider the following options:

- start at higher input levels
- resize and/or relocate the gas controls

### A flame monitoring system consists of two main parts:

- a flame sensor
- flame monitoring control

#### Flame sensor

There are two types that you can use for an ImmersoJet burner:

- U.V. scanner
- flame rod

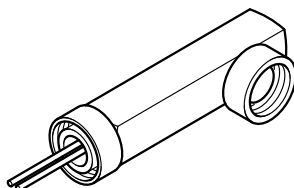
You can find U.V. scanner information in:

- Info Guide 852; 90° U.V. scanner
- Info Guide 854; straight U.V. scanner
- Info Guide 855; Solid State U.V.I.R. scanner
- Info Guide 856; self-check U.V. scanner.

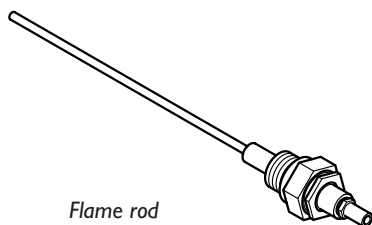
You can find flame rod information in:

- Bulletin / Info Guide 832

## STEP 5: FLAME MONITORING SYSTEM



U.V. scanner



Flame rod



## **STEP 6: COMBUSTION AIR SYSTEM**

### **Flame Monitoring Control**

The flame monitoring control is the equipment that processes the signal from the flame rod or the U.V. scanner.

For flame monitoring control you may select several options:

- flame monitoring control for each burner: if one burner goes down, only that burner will be shut off
- multiple burner flame monitoring control: if one burner goes down, all burners will be shut off

There are three recommended flame monitoring controls:

- Bi-flame series; see Instruction Manual 826
- Multi-flame series 6000; see Instruction Manual 820
- Veri-flame; see Instruction Manual 818

Other manufacturer's flame monitoring systems can be used with the burner if spark is maintained for a fixed time interval and is not interrupted when a flame signal is detected during trial for ignition.

### **ImmersoJet burners are sold in these configurations:**

- Burner with integral low pressure blower.
- Burner with integral high pressure blower.
- Burner less blower.



#### Note:

This section describes how to size a blower for burners purchased less blower.

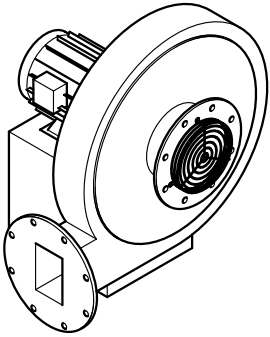
### **Effects of atmospheric conditions**

The blower data is based on the International Standard Atmosphere (ISA) at Mean Sea Level (MSL), which means that it is valid for:

- sea level
- 29.92" Hg (1,013 mbar)
- 70°F (21°C)

The make-up of the air is different above sea level or in a hot area. The density of the air decreases, and as a result, the outlet pressure and the flow of the blower decrease. An accurate description of these effects is in the Eclipse Combustion Engineering Guide (EFE 825). The Guide contains tables to calculate the effect of pressure, altitude and temperature on air.

## COMBUSTION AIR SYSTEM (CONTINUED)



Series SMJ turbo blower

### Blower

The rating of the blower must match the system requirements. You can find all the blower data in Bulletin 610.

Follow these steps:

#### 1. Calculate the outlet pressure.

When calculating the outlet pressure of the blower, the total of these pressures must be calculated.

- the static air pressure required at the burner
- the total pressure drop in the piping
- the total of the pressure drops across the valves
- the pressure in the immersion tube
- recommend a minimum safety margin of 10%

#### 2. Calculate the required flow

The blower output is the air flow delivered under standard atmospheric conditions. It must be enough to feed all the burners in the system at high fire.

Combustion air blowers are normally rated in terms of standard cubic feet per hour (scfh) of air.

An example calculation follows the information tables below:

**Figure 3.4 Required calculation information**

DESCRIPTION	UNIT OF MEASURE	FORMULA SYMBOL
Total system heat input	Btu/hr	Q
Number of burners	-	-
Type of fuel	-	-
Gross heating value of fuel	Btu/ft <sup>3</sup>	q
Desired excess air percentage (Typical excess air percentage @ high fire is 15%)	percent	%
Air/Gas ratio (Fuel specific, see table below)	-	$\alpha$
Air flow	scfh	V <sub>air</sub>
Gas flow	scfh	V <sub>gas</sub>

**Figure 3.5 Fuel gas heating values**

FUEL GAS	STOICHIOMETRIC* AIR/GAS RATIO $\alpha$ (ft <sup>3</sup> <sub>air</sub> /ft <sup>3</sup> <sub>gas</sub> )	GROSS HEATING VALUE q (Btu/ft <sup>3</sup> )
Natural gas (Birmingham, AL)	9.41/1	1,002
Propane	23.82/1	2,572
Butane	30.47/1	3,225

\* Stoichiometric: No excess air. The precise amount of air and gas are present for complete combustion.

## COMBUSTION AIR SYSTEM (CONTINUED)

### Application example:

A designer of a spray washer has determined the heat input for the water tank requires 857,500 Btu/hr. Based on the size of his tank, he has selected a tube efficiency of 70% which results in a gross burner input of 1,225,000 Btu/hr.

### Calculation example to determine the air flow requirement:

a. *Decide which ImmersoJet model is appropriate:*

- From the capacity table, either the 4" with a remote blower (1,800,000 Btu/hr), or the 6" with the low-pressure packaged blower (2,000,000 Btu/hr) have sufficient capacity. For this example, the designer selects the 4" tube because his tank size limits the amount of the larger 6" tube that will fit.
- Select an IJ004, 4" diameter tube ImmersoJet burner with a remote blower for a maximum firing rate of 1,225,000 Btu/hr.

b. Calculate the required gas flow:

$$V_{\text{gas}} = Q/q = 1,225,000 \text{ Btu/hr} / 1,002 \text{ Btu/ft}^3 = 1,223 \text{ ft}^3/\text{hr}$$

- Gas flow of 1,223 ft<sup>3</sup>/hr is required.

c. Calculate the required stoichiometric air flow:

$$V_{\text{air-stoichiometric}} = a (\text{air/gas ratio}) \times V_{\text{gas}} = 9.41 \times 1,223 \text{ ft}^3/\text{hr} = 11,508 \text{ ft}^3/\text{hr}$$

- Stoichiometric air flow of 11,508 scfh required

d. Calculate the final blower air flow requirement based on 15% excess air at high fire:

$$V_{\text{air}} = (1 + \text{excess air \%}) \times V_{\text{air-stoichiometric}} = (1 + 0.15) \times 11,508 \text{ ft}^3/\text{hr} = 13,234 \text{ ft}^3/\text{hr}$$

- For this example, final blower air flow requirement is 13,234 scfh at 15% excess air.



Note:

*It is common practice to add an additional 10% to the final blower air flow requirement as a safety margin.*

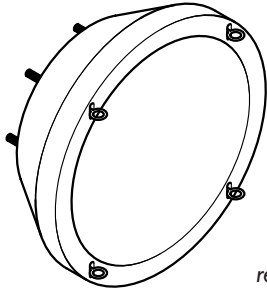
3. Find the blower model number and motor horsepower (hp).

With the output pressure and the specific flow, you can find the blower catalog number and the motor hp in Bulletin 610.

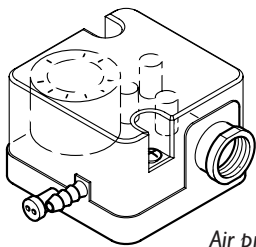
4. Select the other parameters:

- inlet filter or inlet grille
- inlet size (frame size)
- voltage, number of phases, frequency
- blower outlet location, and rotation direction Clockwise (CW) or Counter Clockwise (CCW).

**Step 6: Combustion Air System: Blower and air pressure switch (continued)**



Inlet filter with replaceable filter element



Air pressure switch

**Step 7: Main gas shut-off valve train**



**STEP 8: PROCESS TEMPERATURE CONTROL SYSTEM**



**Note:**

The use of an inlet air filter is strongly recommended. The system will perform longer and the settings will be more stable.



**Note:**

When selecting a 60 Hz Blower for use on 50 Hz, a pressure and capacity calculation is required. See Eclipse Combustion Engineering Guide (EFE 825)

The total selection information you should now have:

- blower model number
- motor hp
- motor enclosure (TEFC)
- voltage, number of phases, frequency
- rotation direction (CW or CCW).

**Air pressure switch**

The air pressure switch gives a signal to the monitoring system when there is not enough air pressure from the blower.

You can find more information on pressure switches in:

- Blower Bulletin 610



**Warning:**

**Eclipse Combustion supports NFPA regulations, which require the use of an air pressure switch in conjunction with other safety components, as a minimum standard for main gas safety shut-off systems.**

**Consult Eclipse**

Eclipse can help you design and obtain a main gas shut-off valve train that complies with the current safety standards.

The shut-off valve train must comply with all the local safety standards set by the authorities that have jurisdiction.

For details, please contact your local Eclipse Combustion representative or Eclipse Combustion.



**Note**

Eclipse Combustion supports NFPA regulations (two shut-off valves) as a minimum standard for main gas safety shut-off systems.

**Consult Eclipse**

The process temperature control system is used to control and monitor the temperature of the system. There is a wide variety of control and measuring equipment available.

For details, please contact your local Eclipse Combustion representative or Eclipse Combustion.



# Appendix

## CONVERSION FACTORS

### Metric to English.

FROM	TO	MULTIPLY BY
cubic meter (m <sup>3</sup> )	cubic foot (ft <sup>3</sup> )	35.31
cubic meter/hour (m <sup>3</sup> /h)	cubic foot/hour (cfh)	35.31
degrees Celsius (°C)	degrees Fahrenheit (°F)	(°C × 1.8) + 32
kilogram (kg)	pound (lb)	2.205
kilowatt (kW)	Btu/hr	3414
meter (m)	foot (ft)	3.28
millibar (mbar)	inches water column ("wc)	0.401
millibar (mbar)	pounds/sq in (psi)	14.5 × 10 <sup>-3</sup>
millimeter (mm)	inch (in)	3.94 × 10 <sup>-2</sup>

### Metric to Metric.

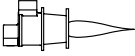
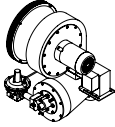


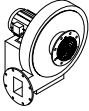
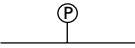

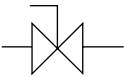

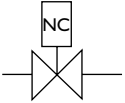
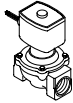
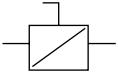

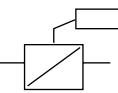

FROM	TO	MULTIPLY BY
kiloPascals (kPa)	millibar (mbar)	10
meter (m)	millimeter (mm)	1000
millibar (mbar)	kiloPascals (kPa)	0.1
millimeter (mm)	meter (m)	0.001

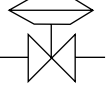
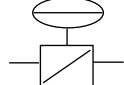

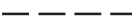
### English to Metric.

FROM	TO	MULTIPLY BY
Btu/hr	kilowatt (kW)	0.293 × 10 <sup>-3</sup>
cubic foot (ft <sup>3</sup> )	cubic meter (m <sup>3</sup> )	2.832 × 10 <sup>-2</sup>
cubic foot/hour (cfh)	cubic meter/hour (m <sup>3</sup> /h)	2.832 × 10 <sup>-2</sup>
degrees Fahrenheit (°F)	degrees Celsius (°C)	(°F – 32) ÷ 1.8
foot (ft)	meter (m)	0.3048
inches (in)	millimeter (mm)	25.4
inches water column ("wc)	millibar (mbar)	2.49
pound (lb)	kilogram (kg)	0.454
pounds/sq in (psi)	millibar (mbar)	68.95

## KEY TO SYSTEM SCHEMATICS

These are the symbols used in the schematics.

SYMBOL	APPEARANCE	NAME	REMARKS	BULLETIN/ INFO GUIDE
		Immersojet burner		
		Main gas shutoff valve train	Eclipse Combustion, Inc. strongly endorses NFPA as a minimum	756
		Combustion air blower	The combustion air blower provides the combustion air pressure to the burner (s).	610
		Air pressure switch	The air pressure switch gives a signal to the safety system when there is not enough air pressure from the blower.	610 I-354
		Gas cock	Gas cocks are used to manually shut off the gas supply on both sides of the main gas shut-off valve train.	710
		Solenoid valve (normally closed)	Solenoid valves are used to automatically shut off the gas supply on a bypass gas system or on small capacity burner systems.	760
		Manual butterfly valve	Manual butterfly valves are used to balance the air or gas flow at each burner, and/or to control the zone flow.	720
		Automatic butterfly valve	Automatic butterfly valves are typically used to set the output of the system.	720

SYMBOL	APPEARANCE	NAME	REMARKS	BULLETIN/ INFO GUIDE
		Ratio regulator	<p>A ratio regulator is used to control the air/gas ratio. The ratio regulator is a sealed unit that adjusts the gas flow in ratio with the air flow. To do this, it measures the air pressure with a pressure sensing line, the impulse line. This impulse line is connected between the top of the ratio regulator and the air supply line.</p> <p>The cap must stay on the ratio regulator after adjustment.</p>	742
		CRS valve	<p>A CRS valve is used in a high/low time-proportional control system to quickly open and close the air supply.</p>	744
		Pressure taps	<p>The schematics show the advised positions of the pressure taps.</p>	
		Impulse line	<p>The impulse line connects the ratios regulator to the air supply line.</p>	



---

**Eclipse Combustion**

*www.eclipsenet.com*

*ISO 9001 Registered*